

Cryogen-Free Measurement System (CFMS)

World Leaders in
Cryogen-Free
Technology

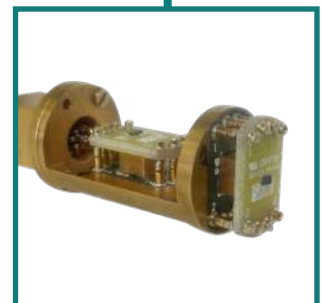
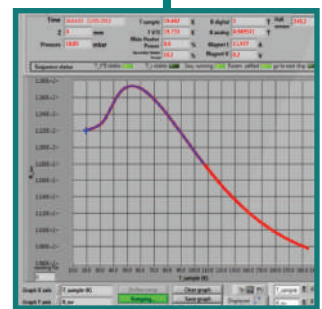
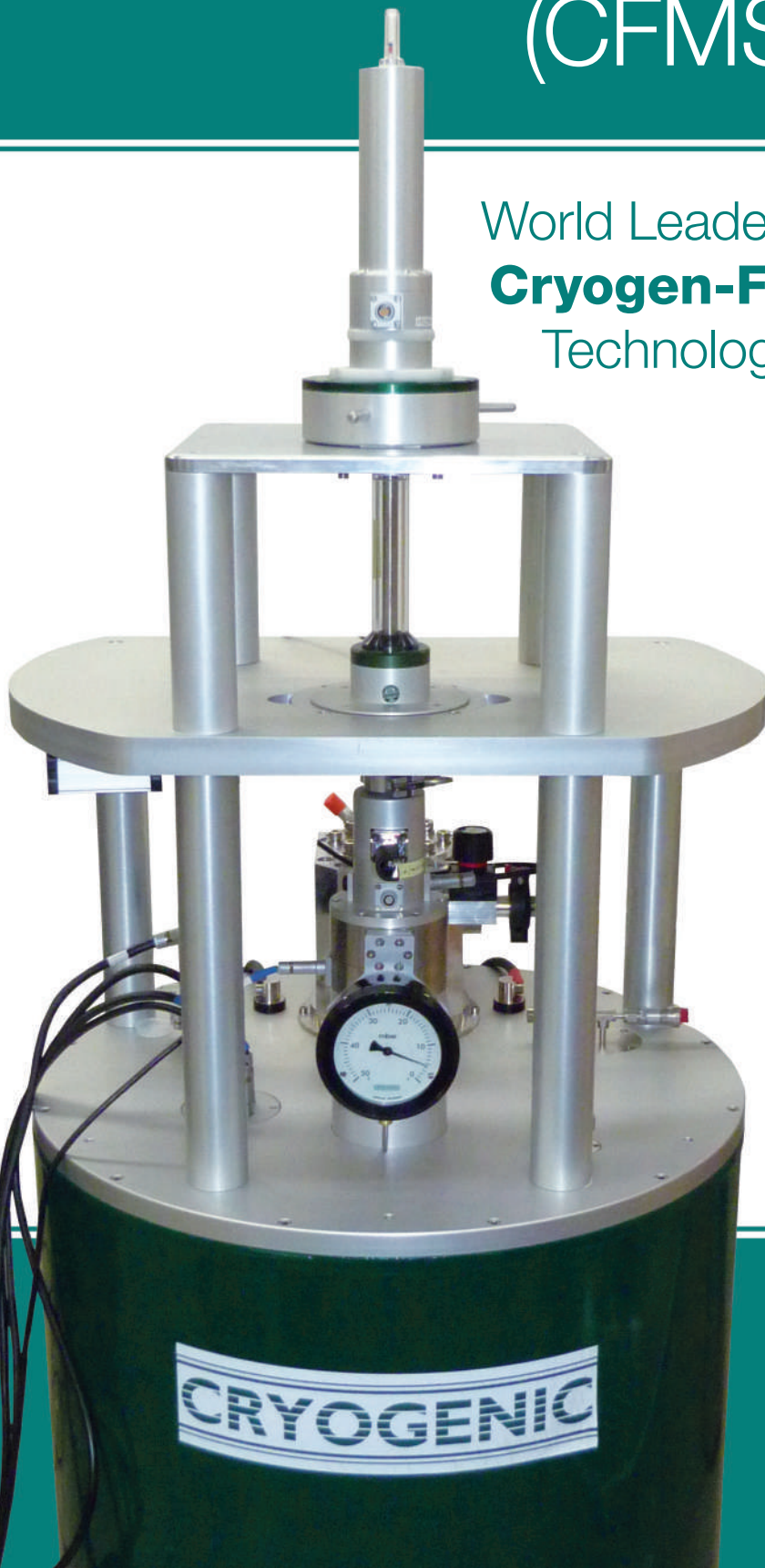

CRYOGENIC

www.cryogenic.co.uk

Cryogen-Free System Platforms

Cryogenic Ltd is the leading supplier of superconducting magnets and low temperature measurement systems which operate without liquid helium.

We continually invest in our products, processes and accompanying technologies in order to maintain our success as the market leader in the supply of cryogen-free systems for research in physics, chemistry and medicine to the international market place.

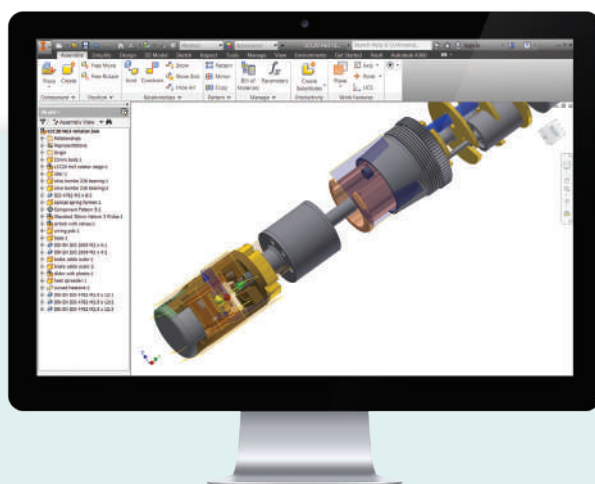

Design



Build



Complete



Our objective is to continually improve our product portfolio of user friendly cryogen-free technology as the practical difficulties and expense of operating liquid based systems becomes more acute each year. The capabilities of our measurement systems are routinely being extended as new and innovative measurement options which can access an ever increasing temperature range are added.

Our ongoing product development and business growth is founded upon successful project completion and customer feedback. We fully understand the need of supporting our customers. In addition to field service and direct access to our engineers, we are also able to provide online diagnosis of system performance and functionality to provide peace of mind and maintain the most efficient throughput of samples.

For system maintenance we have a network of qualified support staff that can carry out in-field servicing worldwide.



Aftercare



System



Results

Cryogen-Free Platform

Magnetic Field up to 18 T

The Cryogen-Free Measurement System (CFMS) from Cryogenic Ltd is a modular research platform designed to enable the user to perform a wide range of material characterisation experiments in variable field and variable temperature environments.

The base system of every CFMS is made up of a cryogen-free superconducting magnet with an Integrated Variable Temperature Insert (IVTI). An automatic needle valve is available for ease of system control. Complementing this is a range of specifically designed measurement modules with associated electronics for magnetic, electrical, thermal property and ultra-low temperature measurements.

Magnet configurations up to ± 18 Tesla are available with a standard temperature range of 1.6 K – 400 K. Active shielding is available for magnets of 9 T and higher. The VTI base may, as an option, include optical access in line with the sample column axis to allow for sample illumination from below the cryostat.



Performance

Maximum magnetic field	9 – 18 Tesla
Central field homogeneity for VSM	0.01% over 3cm x \varnothing 1cm cylinder at field centre
Cooldown time	24 – 48 hours
System continuous operation	30,000 hours

Electronics

Cryogenic Ltd supplies its systems with a wide range of brand name electronics such as Keithley voltage and current source, and LakeShore temperature controllers.

20 bit Superconducting Magnet Power Supply:

Cryogenic SMS power supplies are designed and made in house to suit varying system specifications. High resolution 20 bit power supplies are provided as standard for high stability. Cryogenic's LabVIEW based software allows automated control of the power supply.

Integrated Variable Temperature Insert (IVTI)

Temperature Stability

The sample temperature stability was recorded at high & low temperatures. At each temperature, data were recorded continuously for 8 hours. The standard deviation of the measured temperature from the setpoint is shown in the table.

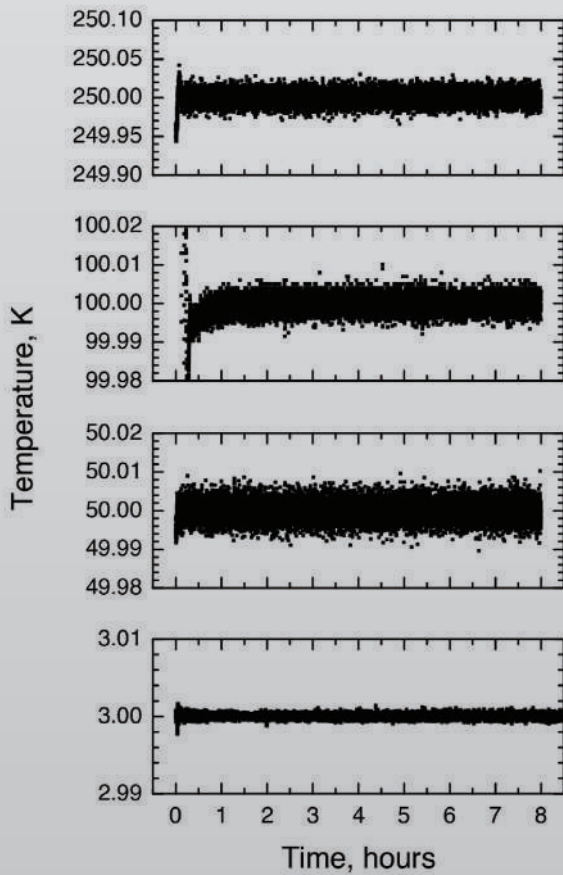

Temperature, K	Standard deviation, mK
3	0.3
50	2.4
100	2.0
250	8.0

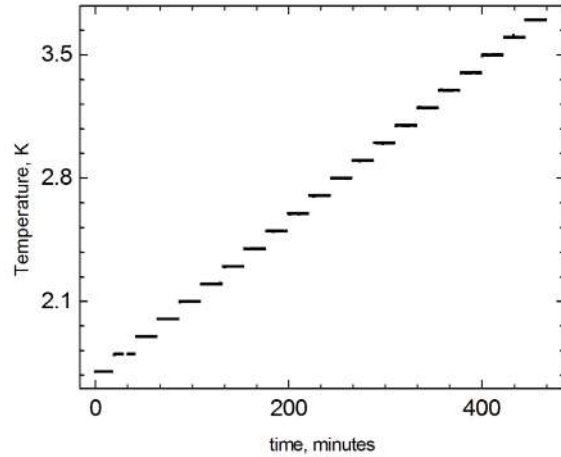

0.1 K temperature steps, showing fine control of the sample temperature at low temperatures

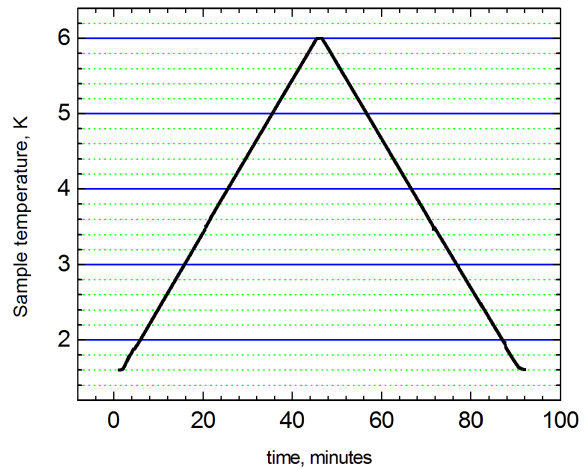

Ramp of the sample temperature from 1.6 K to 6 K, showing smooth temperature control through 4 K

Software

Every Cryogen-Free measurement system is supplied with an independent, fully integrated control application for Windows, containing interfaces for customised Labview and Python scripts. Full access to raw data for post measurement analysis and reporting is provided.

Contents — Measurement Range



Magnetic Measurements

8–11

- » Vibrating Sample Magnetometer (VSM)
- » AC Magnetic Susceptibility
- » Heated VSM (up to 700 / 1000 K)
- » Ferromagnetic Resonance (FMR)



Electrical Measurements

12–13

- » DC Resistance and Hall Effect
- » AC Resistance and Hall Effect
- » Heated Resistivity Probe Option
- » Single and Double Axis Rotators



Thermal Property Measurements

14–17

- » Heat Capacity
 - » AC Calorimeter Method
 - » Relaxation Method
- » Thermal Transport



Ultra-Low Temperature

18–19

- » ^3He refrigerator Insert down to 300 mK
- » Single Axis Rotator
- » Dilution Refrigerator Insert down to 50 mK

Magnetic moment vs Field at 1.6 K

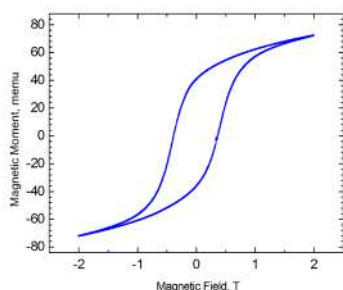

The magnetic properties measurement module comprises a Vibrating Sample Magnetometer (VSM) for measurements of DC magnetic moment, and an AC Susceptometer for measurements of AC magnetic susceptibility. A heated sample platform compatible with both measurements is available.

Resistance vs Temperature in zero applied field

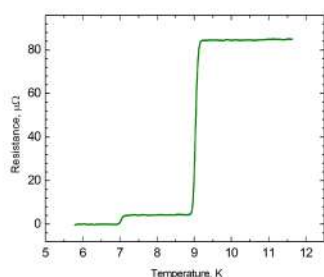

The electrical properties measurement module provides a range of techniques using DC or AC current or voltage sources, and a selection of sample mounts with a different number of contacts, suitable for different sample geometries. The temperature range available with this module can be extended up to 700 K using the heated sample probe, or down to 300 mK using the ^3He insert. Rotating sample platforms are available.

Heat capacity vs Temperature in zero applied field

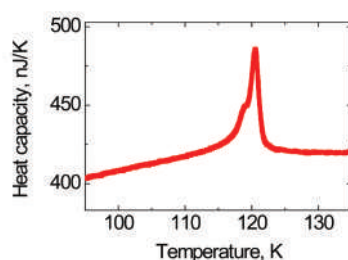

Cryogenic offers sensitive probes for measurements of heat capacity, and a Thermal Transport probe for combined measurement of thermal conductivity, thermal EMF (or Seebeck coefficient) and electrical resistance. The software can then calculate the thermoelectric figure of merit. These measurements require thermal and electrical contacts at opposite sides of the sample and the probe is adaptable to different geometries.

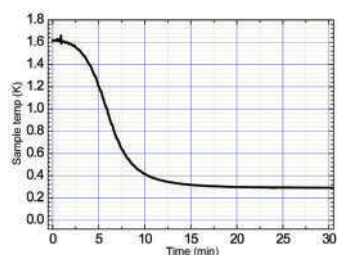
Cooldown of a sample from 1.6 K (IVTI base temperature) to a ^3He pot base temperature of less than 300 mK

For users who need ultra-low temperatures and a high magnetic field, Cryogenic Ltd manufacture specialised ^3He Refrigerators and Dilution Refrigerators designed for operation inside the cryogen-free measurement system sample space. Both refrigerators are fully compatible with all AC and DC electrical property measurement options.

Magnetic Measurements

Vibrating Sample Magnetometer (VSM)

The Cryogenic VSM is designed to measure DC magnetic moment. In order to generate a signal proportional to the magnetic moment, the sample is set to vibrate in a constant (or slowly varying) applied field. The signal is detected by a pair of pick-up coils. The coils sense the variation of magnetic flux due to the sample movement. The pick-up coils are located inside the Variable Temperature Insert (VTI) within the bore of the superconducting magnet. The signal is detected by a lock-in amplifier.

Key Features

- » Magnet able to operate in swept or persistent mode
- » Automated gas handling system and calibration procedure
- » Pick-up coils located close to the samples for highest sensitivity
- » Vibrator fitted with moving coil motion detector for amplitude control
- » Rigid and thermally stable carbon fibre sample rod
- » Combined VSM and AC susceptibility module
- » Active vibration compensation of the drive motor

Key

1. VSM Vibrator
2. Vibration Compensation Unit
3. Vertical Translation
4. Perspex Airlock
5. Pulse Tube Cryocooler
6. High Homogeneity Magnet

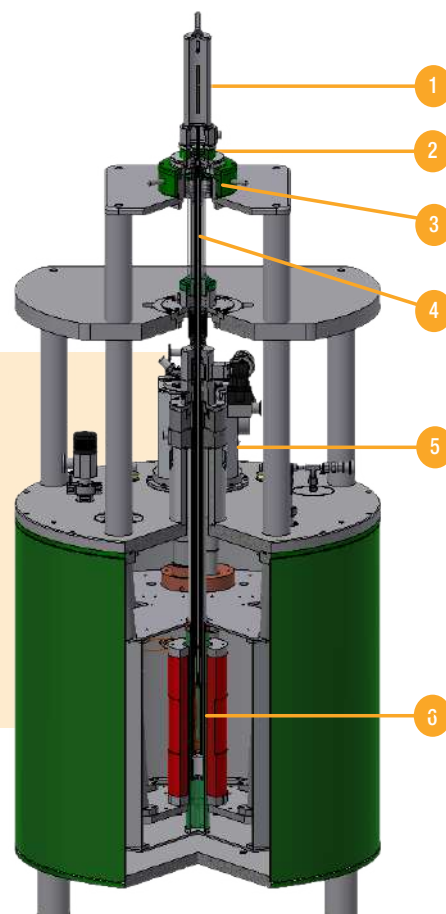

Performance

VSM frequency	20 Hz typical
VSM amplitude	2 mm
Measurement Range	10^{-6} to 100 emu
Sample size	<5 mm
RMS Sensitivity from 0 T to 9 T	$< 10^{-6}$ emu

Noise Independent of Field

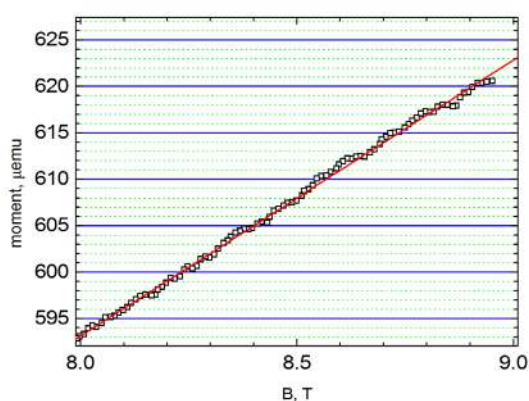

Magnetic moment of a hard disk drive as a function of applied field, plotted from 8 T to 9 T. The red line is a linear fit.

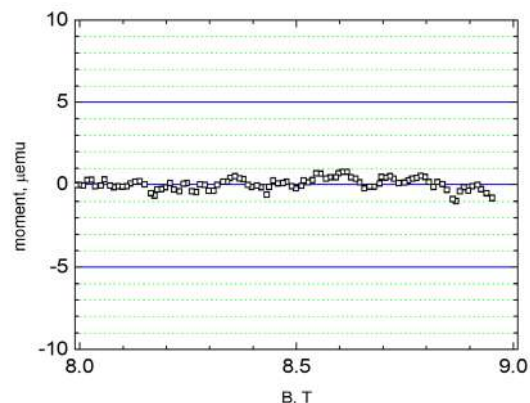

Result of subtracting the linear fit from the data shown on the left. The sensitivity is within $1 \mu\text{emu}$, even at 9 T.

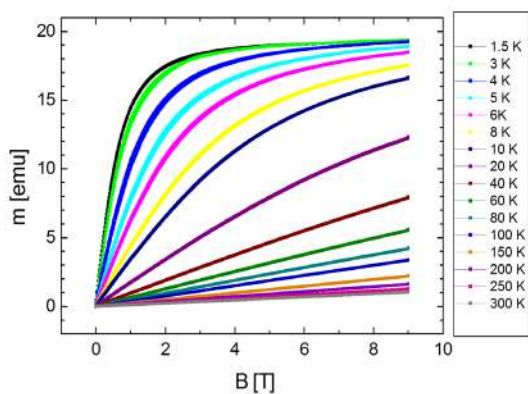

Magnetic moment of the paramagnetic material $Gd_2(SO_4) \cdot 8H_2O$ as a function of field at different temperatures.

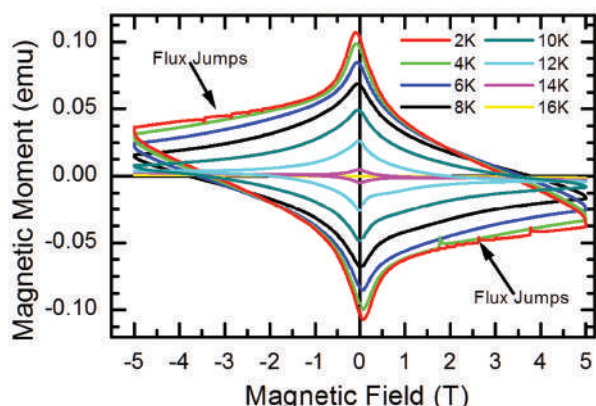

Magnetic moment of a short sample Nb_3Sn conductor as a function of magnetic field, at different temperatures. Flux jumps occur at 2 K, but not at higher temperatures.

Ferromagnetic Resonance Spectroscopy

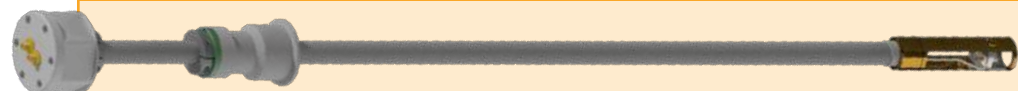

Ferromagnetic resonance (FMR) is a powerful experimental technique for studying ferromagnetic materials. It is used to measure the gyromagnetic ratio, anisotropy field, and damping constant of magnetic materials. This system uses a coplanar waveguide probe and vector network analyzer (VNA) to measure the microwave absorption in a thin film sample as a function of DC field.

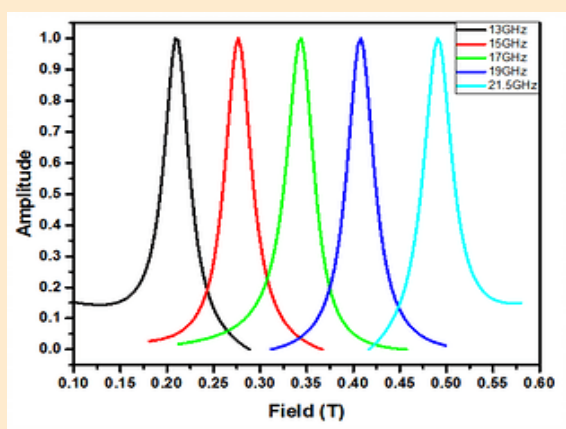

Response of a magnetic thin film with perpendicular anisotropy measured at select frequencies (Data provided by Spectrum Magnetics).

Specification

- » Broadband FMR measurement (up to 50 GHz)
- » Magnetic fields up to 18 T
- » Magnetic field resolution better than 1 mT
- » Full 2-port S parameters analysis (magnitude and phase)
- » In-plane and out-of-plane FMR measurement

Advantages of VNA

- » Simultaneous measurement of real and imaginary part of signal
- » Fixed field swept frequency measurements possible
- » Greater usability, stable and flexible approach
- » Modern state-of-the art technique
- » Brand-name VNA can be used for other experiments

Magnetic Measurements

Heated VSM Probes

Two heated VSM probes are offered to allow measurement of the DC magnetic moment at temperatures of up to either 700 K or 1000 K. Both of these probes feature a specially designed sample mount to ensure excellent temperature control. The 700 K probe works with a 14 mm coil set. The 1000 K probe comes with a specially designed set of pick-up coils to withstand the elevated temperatures. These probes are ideally suited for studying the Curie temperature of various materials.

Key Features

- » Sample in vacuum
- » Sample mounts for parallel or perpendicular alignment to B
- » Miniature, non-magnetic wire-wound heater at the end of the vibrating rod
- » Non-magnetic Pt thermometer

Typical Measurements

- » Bulk samples
- » Thin films
- » Powders



700 K VSM and ACS	
Standard temperature range	200 K - 700 K
Sample size	5 mm x 5 mm x 5 mm

1000 K VSM	
Standard temperature range	200 K - 1000 K
Sample size	3 mm x 3 mm x 3 mm

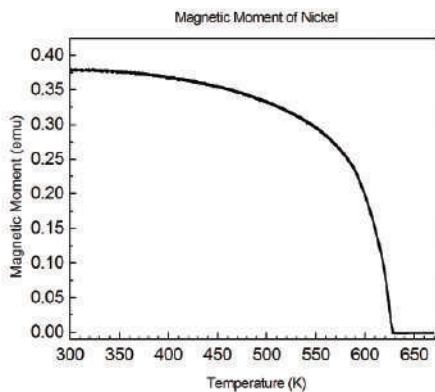

Magnetic moment as a function of temperature for a standard nickel sample measured up to 700 K.

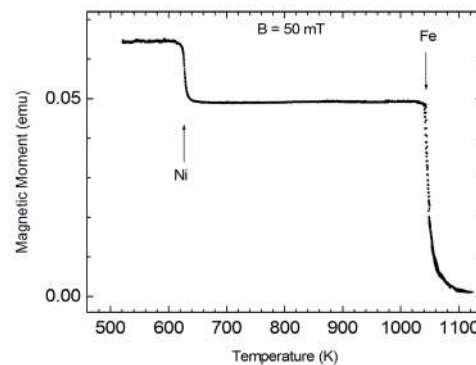

Magnetic moment as a function of temperature of nickel and iron samples measured up to 1000 K.

AC Magnetic Susceptibility

AC susceptibility is measured from the response of a sample to oscillating magnetic field. In simple materials and at low frequencies, the sample's magnetic moment follows the field synchronously, the measured AC signal has the same phase as the oscillating field and the susceptibility measures the derivative of the magnetic moment, dm/dH . In more complex situations where magnetodynamics is involved, there is a phase lag between the susceptibility signal and the field, so that the result can be presented as real (in-phase) and imaginary (out-of-phase) parts of the susceptibility. The method is particularly useful for studying magnetodynamics and phase transitions.

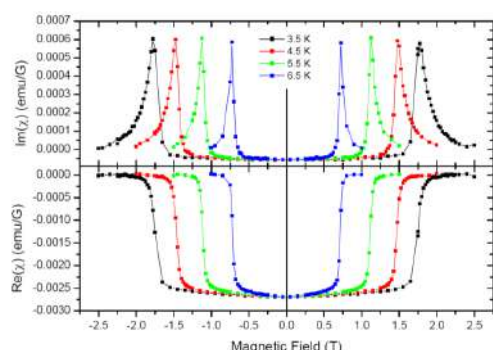

Temperature range

Low temperature superconducting alloy measured using AC susceptibility with automatic background subtraction. The real and imaginary parts of the signal are measured simultaneously. The superconducting transition can be seen as a step in the real part and a sharp peak in the imaginary part of the signal.

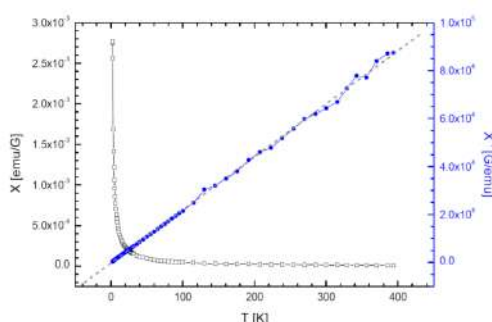

Gadolinium sulphate ACS vs temperature

AC susceptibility of $Gd_2(SO_4)_3 \cdot 8H_2O$ with sample extraction from the coils set and compensation of background signal.

Typical Measurements

- » Magnetic phase transitions
- » Magnetic characterisation
- » Superconducting phase transition
- » Spin-glasses

Performance

Frequency range	1 Hz to 9 kHz
AC field amplitude	≤ 5 mT @ 10 Hz
Sample size	Typically < 6 mm
Phase setting accuracy	0.1° (Real and Imaginary Parts)
Sensitivity at 1kHz	10^{-7} emu/Gauss

Key Features

- » Parasitic signals eliminated by moving sample between pick-up coil centres
- » Auto sample position optimisation routine
- » Wide frequency range with high sensitivity
- » Possibility to interchange between VSM and AC magnetic susceptibility measurement techniques without removing the sample

Electrical Measurements

Resistivity and Hall Effect (DC & AC)

The Electrical Transport module provides a capability to perform DC resistance measurements and Hall voltage measurements in samples with resistance in the range from 100 nΩ to 1 GΩ. Cryogenic offers a selection of sample platforms with different numbers of sample connections and suitable for different sample sizes. Probe wiring options include twisted pairs, miniature coaxial cables (for high-frequency measurements) or triaxial lines (for very low current measurements).

We offer a module to conduct AC resistance measurements. The option includes a special sample probe with micro-coaxial cable wiring, Keithley AC/DC current source and Zurich Instruments Lock-in amplifier.

Typical DC Measurements

- » Resistance & magnetoresistance
- » Current-Voltage (I-V) characteristics
- » Critical current
- » Hall Effect
- » Automated Van Der Pauw

Typical AC Measurements

- » Real and imaginary parts of impedance Z
- » Varying temperature: Z(T)
- » Varying magnetic field: Z(H)
- » Varying source current: Z(I) (I-V characteristic)
- » Hall voltage (4-terminal configuration)

Performance	DC	AC
Noise base	1 nV / √Hz	1 nV / √Hz
Voltage range	10 nV to 100 V	10 nV to 1 V
Current range	1 nA to 1 A	1 pA to 100 mA
AC frequency range	1 mHz to 100 kHz	1 mHz to 100 kHz
Phase-setting accuracy	N/A	0.10 (real & imaginary parts)
Measurement accuracy	N/A	N/A

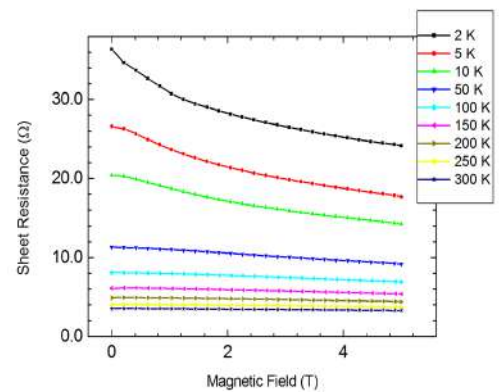

6 pin sample chip and probe end



8 pin sample chip and probe end

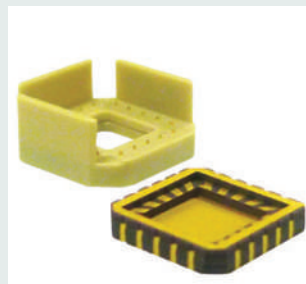

20 pin sample chip Multi sample probe and probe end



Multi sample probe

One-Axis and Two-Axis Rotators

Each insert allows the measurement of the electrical properties of materials at different angles to the magnetic field without the need for remounting. A range of sample mounts are available to suit different sample sizes.

Performance	1.6 K One-Axis Rotator	1.6 K Two-Axis Rotator
Sample platform Type	LCC20 out-of-plane, LCC20 in-plane, 6-pin (5x10mm), 8-pin (10x10 mm)	LCC20
Angular Range	330 degrees	180 degrees in each axis
Position Control	Built-in sensor	Home position detector and hysteresis-free positioning algorithm
Angular Accuracy	0.1 degrees	0.5 degree in each axis

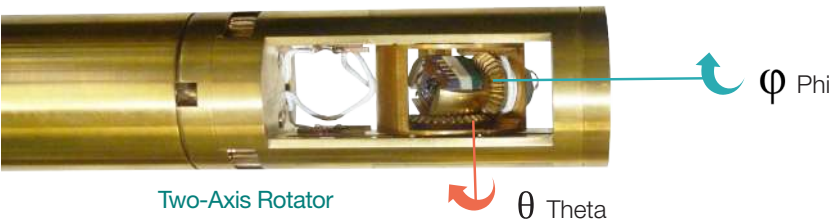

Two-Axis Rotator

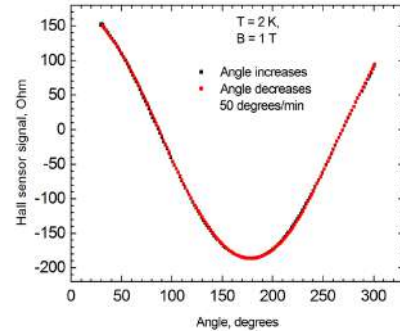

Hall Voltage Measured using a One Axis Rotator.

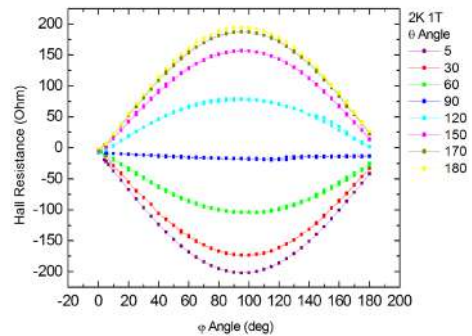

Hall Voltage Measured using a Two Axis Rotator: Theta Sweeps

Heated Resistivity Probe

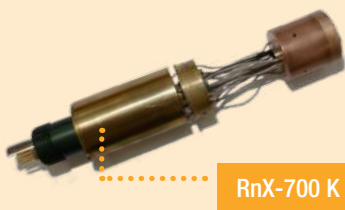

RnX-700 K

- » Temperature range from 200 K – 700 K
- » Sample space is a 10 mm × 10 mm square, suitable for thin films, sheets or wires
- » Configurable in a $\mu\Omega$ to M Ω range
- » Fits in all Cryogenic measurement systems
- » Allows 2-point, 4-point, Hall and van der Pauw measurements to be made
- » Comes with all necessary electronics and control software

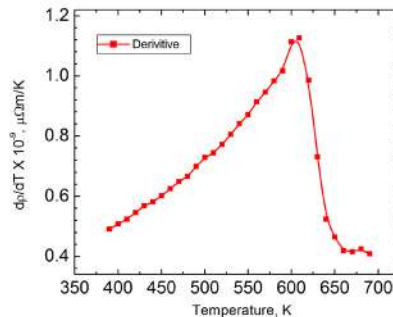
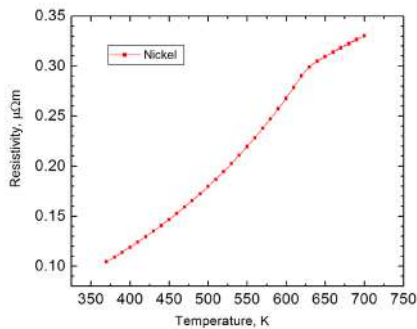

The Curie point of nickel is known to be 632 K. A lower scattering rate is observed in the fully magnetised state, as each scattering event must be accompanied by a spin flip. Therefore a shoulder in the resistance data is observed at the Curie point, which is clearly resolved at the correct temperature as shown in the right panel.

Thermal Property Measurements

Heat Capacity: AC Calorimeter

The Cryogenic Limited miniature AC calorimeter is designed to measure the heat capacity of samples weighing as little as one microgram. The AC technique offers unsurpassed sensitivity combined with simplicity of operation.

The sample is mounted on to the calorimeter membrane using thermally conductive vacuum grease and placed in a closed cell with low-pressure exchange gas. The sample mount is then plugged into the standard probe as shown below. The probe is inserted into the VTI through an airlock.



Performance

Typical Sample mass	1 μg to 200 μg
Typical Sample size	0.1 mm \times 0.1 mm \times 0.1 mm
Sensitivity	1 nJ/K at 10 K

Temperature Modulation

Frequency	0.1 Hz to 100 Hz typical
Amplitude	0.001 K to 0.1 K

Key Features

High Sensitivity:

Small sample size and small temperature excitations allow unparalleled sensitivity - perfect for detecting and studying the details of 1st order phase transitions

Measurement conditions:

Fast data acquisition allows measurement with continuously varying temperature or magnetic field

Optimal Lateral Sample Size:

0.1 mm \times 0.1 mm to match the size of the miniature silicon nitride membrane heater

Sample Environment:

Sample in flowing gas, allowing ease of measurement

Robustness and Durability:

Sensor can be used for multiple sample replacements

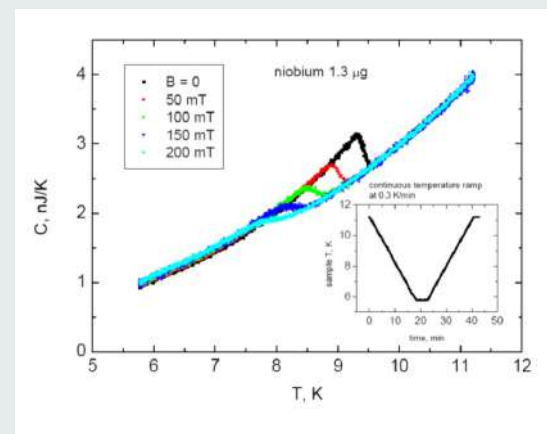

Heat capacity of niobium measured as a function of temperature at different fields using the AC method. The excellent accuracy of this method allows the superconducting transition to be resolved in great detail.

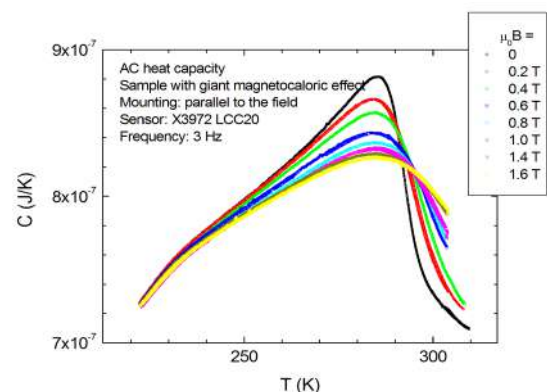

Heat capacity of Gadolinium measured as a function of temperatures at different magnetic fields. The peak in the heat capacity corresponds to the Curie temperature of Gd. The large magnetocaloric effect means that Gd can be used for magnetic cooling.

Heat Capacity: Relaxation Method

The relaxation method is an alternative, and complementary, way of measuring heat capacity. It is intrinsically slower, but allows accurate determination of the absolute value. The measurement is performed using our top-loading vacuum probe. Samples are mounted in a light-weight aluminium container.

Design of the sample platform is adjusted to the expected range of heat capacity, so the method can be used for samples of various sizes by simply replacing the platform.

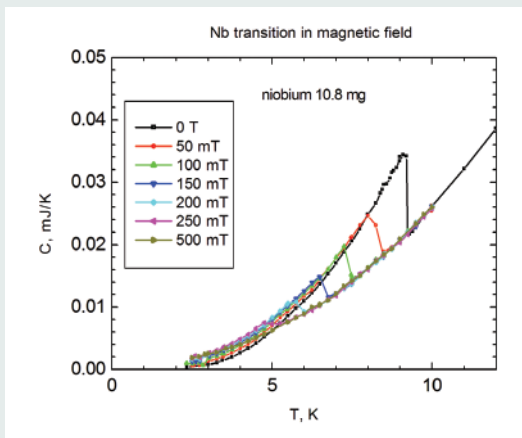

Heat capacity of niobium measured as a function of temperature at different fields using the relaxation method. The superconducting transition can clearly be seen. The large heat capacity measured for this sample allows very accurate measurement of the heat capacity.

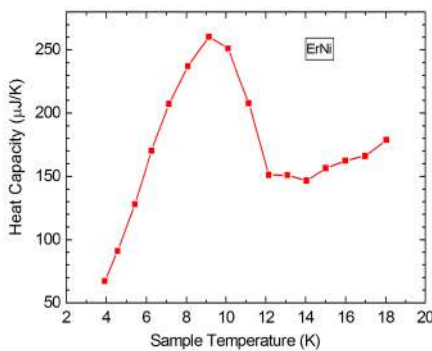

Plot of the heat capacity of ErNi as a function of temperature measured using the relaxation method. The maximum in the heat capacity at close to 10 K corresponds to the Curie temperature of the material. This phase transition makes ErNi a good material for the regenerator in Gifford-McMahon cryocoolers.

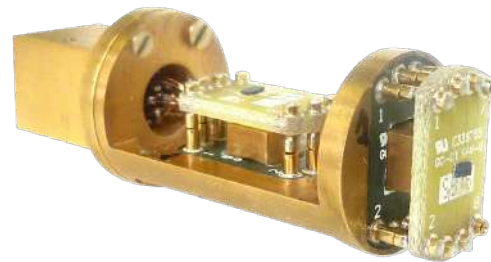

Performance

Typical Sample mass	1 mg to 200 mg
Typical Sample size	1 mm × 1 mm × 1 mm
Sensitivity	1% of full signal

Temperature Pulse

Pulse Length	30 s to 90 s
Amplitude	0.01 to 1 K

Key Features

High accuracy:

Larger sample size compared to AC calorimetry allows more precise measurement of absolute value of heat capacity

Measurement conditions:

Data recorded at constant temperature and magnetic field

Optimal Lateral Sample Size:

1 mm × 1 mm to match the size of the heater size

Sample Environment:

Sample in a vacuum maintained by a turbo-molecular pump

Robustness and Durability:

Sensor can be used for multiple sample replacements

Thermal Property Measurements

Thermal Transport

The thermal transport measurement option is used to measure thermal conductivity, thermal EMF (Seebeck effect) and resistivity simultaneously in a single experimental setup to determine the thermoelectric figure of merit.

The sample platform is mounted inside a cone-sealed inner vacuum chamber (IVC) at the end of a special measurement probe. Wires entering the IVC are carefully thermally grounded so that the operation of the probe at low temperatures is not compromised. To measure the thermal conductivity and thermal EMF, four-point method is employed to eliminate sample boundary effects.



Typical Measurements

- » Thermal Conductivity
- » Seebeck Coefficient
- » Resistivity
- » Thermoelectric Figure of Merit

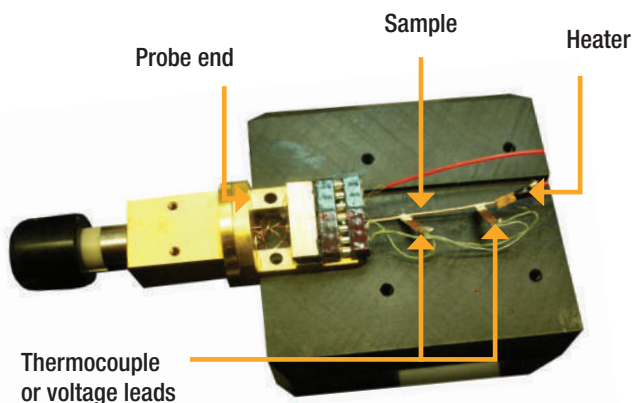

Performance

Temperature range	2 K to 350 K
Typical sample size	1 mm x 1 mm x 10 mm
Range of thermal conductance 300 K	1 μ W/K to 100 mW/K
Range of thermal conductance 10 K	0.1 μ W/K to 10 mW/K
Range of thermal EMF measurement	1 μ V/K to 1 V/K
Absolute accuracy	Better than 5%

Thermal Conductivity of Copper

For pure metals the thermal conductivity is dominated by free electron contributions. At very low temperatures the thermal conductivity rises linearly with temperature due to the increasing number of free electrons. As the temperature is increased further the thermal conductivity falls due to increased scattering from phonons. As a result a maximum is developed near to 20 K. The height and position of this maximum is determined primarily by the density of impurities, which are the dominant source of scattering at low temperatures.

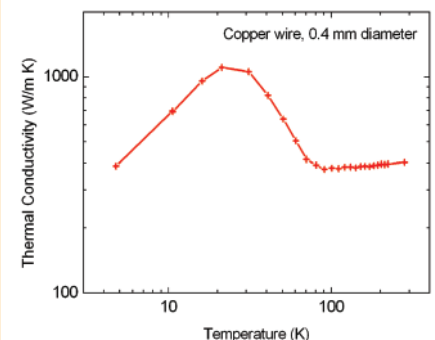

Thermal conductivity, EMF and resistivity are measured simultaneously. The figure of merit is then calculated.

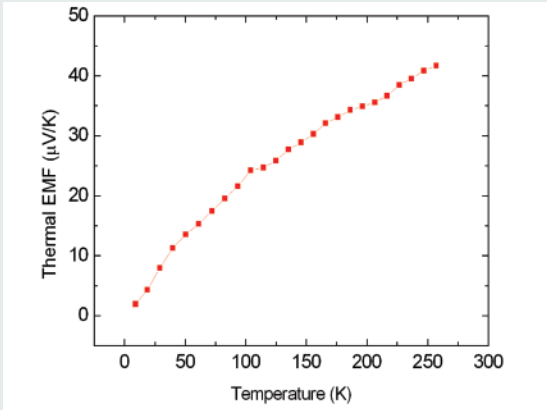

Thermal EMF of a copel (copper-nickel alloy) sample

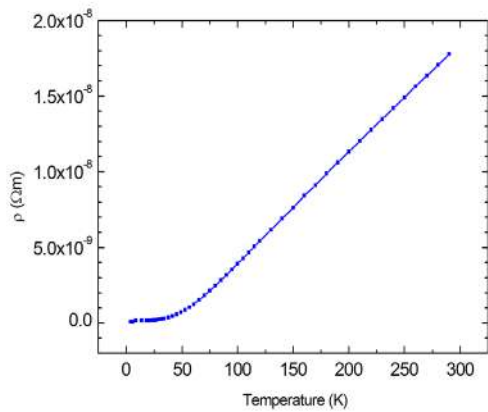

Resistivity of copper wire vs temperature

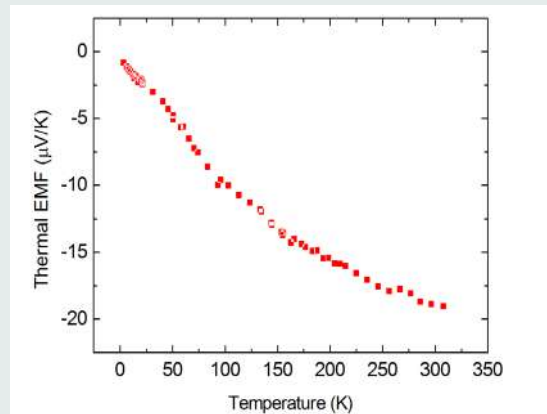

Thermal EMF of a nickel thin film

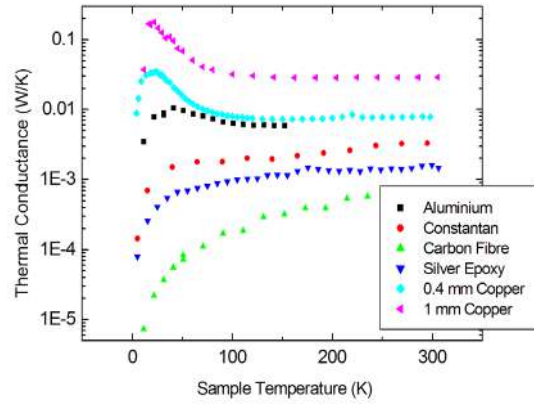

Thermal conductance of various materials, demonstrating the ability to measure a wide range of thermal conductance



5 Tesla mini Cryogen Free Magnet System (mCFM)

Ultra-Low Temperatures

^3He Refrigerator with 300 mK Base Temperature

Using only the cooling power of the VTI and two internal temperature-controlled sorption pumps, the sample platform of the Helium-3 Insert can be maintained at any temperature from 300 mK to above 300 K. The insert fits inside the CFMS variable temperature space and has a working volume of liquid ^3He of approximately 1.5 cc. The standard insert features a gold-plated copper sample mounting surface, with a central tapped hole for mounting of sample sockets. An adaptor is provided to allow the use of standard resistivity sample mounts.

^3He Rotating Platform

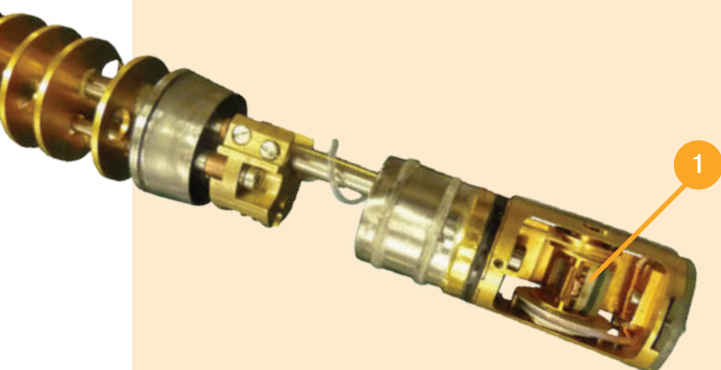

^3He Probe

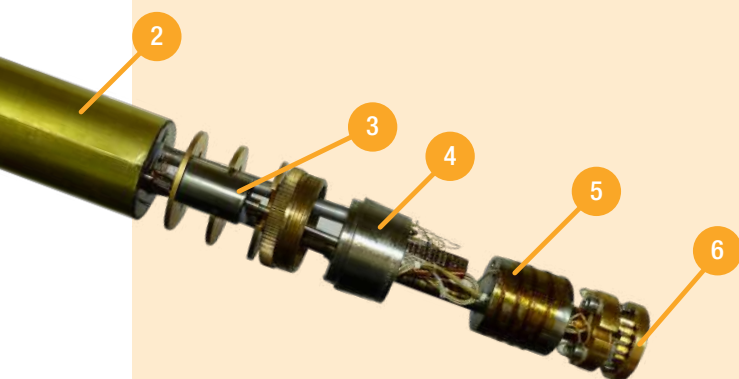

Key

1. Rotating Sample Stage with 20-pin LCC socket
2. Main Sorption pump
3. Exchange Gas Sorption pump
4. Stainless Steel Conical Seal
5. ^3He Pot
6. Standard Sample Stage with 6-Pin Plug-in

Performance

- » Base temperature < 300 mK
- » ^3He condensation stage cooled by VTI
- » Typically 24 hours hold time
- » 2 Hours from room temperature to ^3He condensation temperature
- » 25 minutes to condense 90% of ^3He

Key Features

- » ^3He is permanently sealed within the insert, this prevents accidental gas loss
- » Sample space: 25 mm diameter, 43 mm length
- » No mechanical pumps required for probe operation
- » A range of sample platforms with different contact configurations available
- » Optional rotation stage with LCC20
- » Fully compatible with DC and AC resistivity options

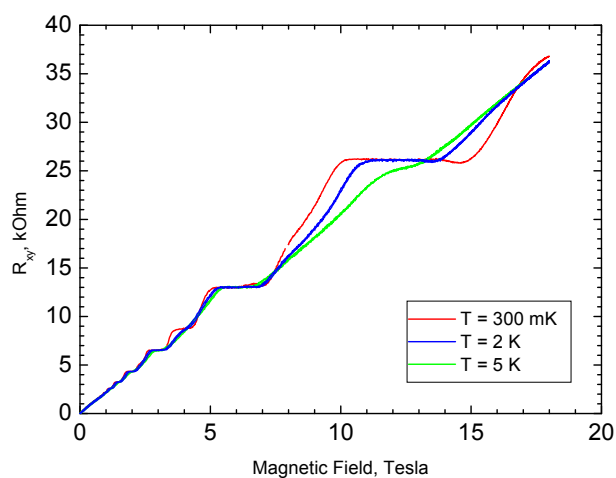

Hall resistance measurement of an GaAs-AlGaAs quantum well. Individual Landau levels are clearly resolved when the measurement is carried out at 300 mK.

Dilution Refrigerator with 30 mK Base Temperature

The Cryogenic Dilution Refrigerator is designed to work within the variable temperature insert. The cooling power of the VTI is used for initial mixture condensation and for continuous circulation mode. The sample platform of the Dilution Refrigerator can be cooled to temperatures below 50 mK in a magnetic field of up to 18 T. The base temperature under constant magnetic field rises only a few mK in comparison with the zero field condition.

The insert features an ultra-low temperature sample socket which is easily accessible through the bottom of the cone seal for sample exchange.



Performance

- » Base temperature <30 mK
- » Cooldown from room temperature to 50 mK within 8 hours

Key Features

- » Sample space 12 mm in diameter
- » Simple access to sample space through conical seal
- » Standard six-pin sample plug-in mounting
- » Three twisted pairs for sample connections fitted as standard
- » Compatible with our standard 30 mm VTI
- » Calibrated resistance sensor fitted to mixing chamber
- » Additional calibrated thermometers for different temperature stages
- » Integrated high vacuum cryopump controllable with a heater
- » Software for operation/data logging with LakeShore 372 resistance bridge
- » Automated gas handling system
- » Fully compatible with DC and AC resistivity options

Key

1. Turbo-Molecular Pump for ^3He Circulation
2. Probe Instrumentation Connectors
3. Still Pumping Line
4. Airlock
5. Indium Seal
6. Inner Vacuum Can (IVC)

System Specifications

Cryogen Free Integrated Variable Temperature Insert

Sample space	30 mm	
Temperature range (with continuous gas flow in VTI)	1.6 K to 400 K	
With optional inserts (not available for all measurements):	Up to 1000 K with heated sample platform. Down to 0.3 K with Helium-3 insert.	
Temperature stability: (with LakeShore series unit)	5 mK @ 10 K 10 mK @ 100 K 50 mK @ 300 K	
Typical sample cooldown time to 1.6 K	60 minutes	
Initial sample cooldown time with VTI at 1.6 K	15 minutes	
Temperature stabilisation time for a typical 10 K temperature step	Accuracy:	Set time:
	± 1 K	10 minute
	± 0.1 K	15 minutes
	± 0.01 K	20 minutes

Standard CFMS

Maximum magnetic field	9 – 18 Tesla
Central field homogeneity for VSM	0.01% over 3cm x Ø 1cm cylinder at field centre
Persistent mode decay rate	30 ppm/hr
Cooldown time	24 – 48 hours
System continuous operation	30,000 hours

Mini CFMS

Maximum magnetic field	3 – 7 Tesla
Central field homogeneity for VSM	0.01% over 3cm x Ø 1cm cylinder at field centre
Cooldown time	< 12 hours
System continuous operation	30,000 hours
Magnetic field stability	> 10 ppm/hr

Resistivity and Hall Effect (DC)

Maximum sample size	5 mm x 10 mm
Supply current range	1 nA to 1 A
Resistance measurement range	100 nΩ to 1 GΩ
Voltage sensitivity	10 nV to 100 V
Accuracy of resistance measurement	< 0.1% 1-10 ⁶ ohm

Vibrating Sample Magnetometer

Vibration amplitude	Typically 2 mm
Vibration frequency	Typically 20 Hz
Maximum sample space	<6 mm
Optimum sample size	2 mm sphere
RMS Noise at 0 T to 9 T	< 1 x 10 ⁻⁶ emu RMS
Dynamic range (standard)	10 ⁸
Accuracy and reproducibility	0.5 % with 2 mm sphere

700 K VSM and ACS

Standard temperature range	200 K – 700 K
Sample size	5 mm x 5 mm x 5 mm

1000 K VSM

Standard temperature range	200 K – 1000 K
Sample size	5 mm x 5 mm x 5 mm

AC Susceptibility

Maximum AC field	20 G at 100 Hz
Sensitivity at 1 kHz	10 ⁻⁷ emu at 4 K
Useful range of frequency	1 Hz to 9 KHz
Maximum sample size	<6 mm diameter

700 K Resistivity

Temperature range	200 K – 700 K
Standard sample size	10 mm x 10 mm square

Resistivity and Hall Effect (AC)

Noise base	1nV / √Hz
Voltage range	1 nA to 1 A
Current range	100 nΩ to 1 GΩ
AC frequency range	10 nV to 100 V
Phase-setting accuracy	0.10 (real & imaginary parts)

Heat Capacity: AC Calorimeter

Typical sample mass	1 µg to 200 µg
Temperature range	3 K to 350 K
Frequency	0.1 to 100 Hz typical
Amplitude	0.01 to 0.1 K
Sensitivity	1 nJ/K at 10 K
Typical sample size	0.1 mm x 0.1 mm x 0.1 mm

Heat Capacity: Relaxation Method

Sample mass	1 mg to 200 mg
Larger sample size	typically 1 mm ³
Sensitivity	1% of full signal
Temperature range	2 K to 350 K

Thermal Transport

Temperature range	2 – 350 K
Range of thermal conductance measurement	1 µW/K – 100mW/K at 300 K 0.1 µW/K – 10 mW/K at 10 K
Absolute accuracy	Better than 5%
Range of thermal EMF measurement	1 µV/K to 1 V/K
Absolute accuracy	Better than 5%
Typical sample size	1 mm x 1 mm x 10 mm

Ultra-Low Field

Supply current range	± 300 mA
Range	20 – 30 mT
Accuracy	10 ⁻⁴
Step size	1 µT

Dilution Refrigerator

Base temperature	<30 mK
Cooldown time from room temperature to 50 mK	300 K – 50 mK in less than 8 hours
Sample space	12 mm diameter Compatible with standard 6 pin resistivity plug-ins

³He Insert: Standard and Rotating

Base temperature	<300 mK
Working temperature range	<300 mK – 325 K
Outer diameter	28 mm (to suit 30 mm VTI)
³ He capacity	Total ³ He gas volume 1.5 STP litres. Working volume in normal use approx 1.0 STP litres.
Initial cooldown time	2 hours from room temperature sample change to ³ He condensation temperature under standard cryogen-free VTI operating conditions
Recondensation time	25 minutes to condense 90% of ³ He charge and cool pot to below 2 K
Performance	24 hours at 285 mK with zero load. 12 hours at 340 mK with 25 µW load. 2 hours at 550 mK with 185 µW load.



"We have used a Cryogenic Limited 14 T cryogen-free measurement system with VSM to measure magnetic properties of Ferrite nanoparticles. We have performed accurate temperature-dependent magnetization measurements in the range of 2 K to 400 K without any interruption, thanks to the robust closed system design."

Dr Kamal Asadi | MPI Mainz

Customer Support

The Cryogenic Customer Support team is committed to quickly and effectively addressing and resolving questions regarding your system. Customer Support staff are available Monday through to Friday from 9:00 AM to 6:00 PM to answer calls and respond to your emails. Cryogenic Ltd uses skills-based routing to ensure that specialized technical engineers are available to address your question. Free Technical support service is also available by e-mail to respond to your concerns and provide support needed for successful running of your system.

Pre-Sales Technical Support

For customers with special requirements our team of experienced physicists and engineers can design and build complex and very sophisticated Cryogenic magnet systems.

Our experienced sales team and technical design staff are always happy to discuss customer requirements in this specialised technology based on our more than 30 years in-depth experience.

Service and Maintenance

Cryogenic has a philosophy to ensure that the systems delivered are installed and used correctly in order to safeguard the customer's investment. Cryogenic's dedicated installation team, based in key locations around the world and at our Head Quarters in the UK, are hugely experienced and boasts detailed knowledge of the complete running of the system.

We have a service team in many international regions, including China, India, Japan, USA and Germany.

Once installed, the user is trained on how to operate the equipment and, of equal importance, how to carry out basic maintenance, thereby reducing service call-outs and prolonging the life of the equipment. Cryogenic has a dedicated training team which takes on these tasks and has vast experience suitable training methods, staff issues and potential pitfalls.

Remote Assistance

All critical parts of our systems are fitted with diagnostic sensors, and the diagnostic information is automatically logged in the background as the system operates. If a customer has difficulties running the system, or has

questions about particular measurements or experiments, our engineers can use remote connection to the system computer in order to perform a comprehensive check of the system's performance, and to provide advice and assistance.

Software Upgrades

We continually work on improving the functionality of the system control software. If you wish to check for updates, please contact the software team for support and assistance.



Please contact our customer service team if you have any concerns using sales@cryogenic.co.uk or complete the customer service form on our website at www.cryogenic.co.uk.

Cryogenic World Wide Network



Key Publications

Giant Magnetoelastic Coupling in a Metallic Helical Metamagnet

Phys. Rev. Lett. 104, 247202
Cambridge University

Low-Temperature Tailoring of Copper-Deficient $\text{Cu}_3\text{-xP}$ —Electric Properties, Phase Transitions, and Performance in Lithium-Ion Batteries

Chem. Mater. 2018, 30, 20, 7111-7123
Technische Universitat Dresden

Macroscopic Quantum Tunneling in Superconducting Junctions of $\beta\text{-Ag}_2\text{Se}$ Topological Insulator Nanowire

ACS Nano 2017, 11, 1, 221-226
Gwangju Institute of Science and Technology (GIST), Korea

Tunneling Magnetoresistance with Sign Inversion in Junctions Based on Iron Oxide Nanocrystal Superlattices

ACS Nano 2011, 5, 3, 1731-1738
University of Salento, Italy

Investigation of Structural, Magneto-transport, and Electronic properties of $\text{Pr}_{0.7}\text{Sr}_{0.3}\text{MnO}_3$ nanoparticle

Journal of Advances In Physics, 7(3).
Indian Institute of Technology Kharagpur, India

Novel magnetic properties of CoTe nanorods and diversified CoTe_2 nanostructures obtained at different NaOH concentrations

Science and Technology of advanced MaTerialS, 18(1), 325-333
Shaanxi Normal University, China

Polycrystalline ZrTe_5 Parametrized as a Narrow-Band-Gap Semiconductor for Thermoelectric Performance

Phys. Rev. Applied 9, 014025
Northwestern University, USA

Synergistic effect of magnetite nanoparticles and carbon nanofibres in electromagnetic absorbing composites

Carbon, 74, 63-72
Universidad Carlos III de Madrid, Spain

Structural, optical and magnetic investigation of Gd implanted CeO_2 nanocrystals

Nuclear Instruments and Methods in Physics Research Section B: Beam Interactions with Materials and Atoms, 409, 147-152
iThemba LABS-National Research Foundation (NRF), South Africa



CRYOGENIC

www.cryogenic.co.uk